



# APPLED ELECTRONICS ENTERPRISES CORPORATION

TEL: (02) 2545881 / 6224308 FAX: (02) 2545881 MOBILE: (0917) 8878378 / (0922) 8878374

STALL NO. 2M-15 168 MALL SOLER ST., BINONDO, MANILA, PHILIPPINES 1006

URL: [WWW.LED.PH](http://WWW.LED.PH)

EMAIL: [APPLED888@YAHOO.COM.PH](mailto:APPLED888@YAHOO.COM.PH)

## INDUSTRIAL LIGHT (70W)

### PARAMETER:

- **Type:** APP-IL-70W-01
- **Light source:** LED
- **Power:** 70W
- **Work voltage:** AC(85V-265V)/(50-60HZ)  
DC(12-24V)
- **Power factor(PF):** >0.9
- **Light efficiency:** >70 lm/w
- **No UV or IR light radiation**
- **Fixture efficiency:** >90%
- **View angle:** 120°
- **Color instruction:** >80
- **Color temperature(CCT):** 2600-7000K
- **Life time:** >50,000 hrs
- **Luminance decrease:** keep lighting 1000hours  
decrease1%
- **IP grade:** IP65
- **CE certification**
- **The color of the lamp shell:** Black/Silvery  
White
- **Net weight:** 4.7kg
- **Dimension of the product(dia. \* H):**  $\Phi 500 \times 441$  mm
- **Dimension of the box:** 56\*56\*19 cm / 53\*39\*27cm
- **Quantity (PCS):** 2 pcs in a carton



### TYPICAL APPLICATIONS:

- **Workshop**
- **Storages**
- **Factories**
- **Shops**
- **Restaurants**
- **Garages**
- **Supermarket etc**



# APPLED ELECTRONICS ENTERPRISES CORPORATION

TEL: (02) 2545881 / 6224308 FAX: (02) 2545881 MOBILE: (0917) 8878378 / (0922) 8878374

STALL NO. 2M-15 168 MALL SOLER ST., BINONDO, MANILA, PHILIPPINES 1006

URL: [WWW.LED.PH](http://WWW.LED.PH)

EMAIL: [APPLED888@YAHOO.COM.PH](mailto:APPLED888@YAHOO.COM.PH)

## PRODUCT DIMENSIONS:

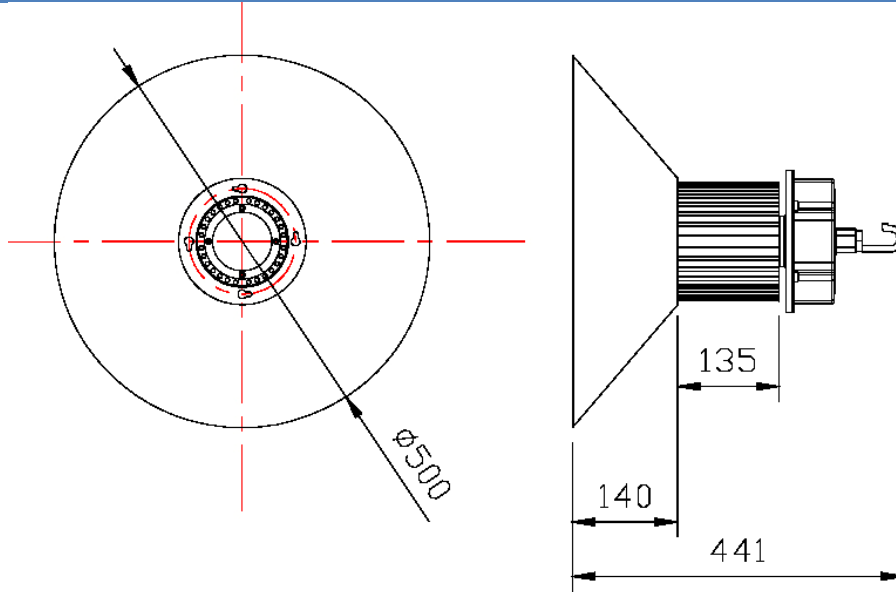

## PHOTOMETRIC RESULTS:

