



## APPLIED ELECTRONICS ENTERPRISES CORPORATION

TEL: (02) 6224308 FAX: (02) 5598778 MOBILE: (0917) 8878378 / (0922) 8878374

STALL NO. 2M-15 168 MALL STA. ELENA ST., BINONDO, MANILA

URL: [WWW.LED.PH](http://WWW.LED.PH)

EMAIL: [APPLED888@YAHOO.COM.PH](mailto:APPLED888@YAHOO.COM.PH)

# FLOOD LIGHT (50W/60W/70W/80W)

## PARAMETER:

- **Type: APP-FL370-02 (50W/60W/70W/80W)**
- **Light source: LED**
- **Power: 50W/60W/70W/80W**
- **Work voltage: AC(85V-265V)/(50-60HZ)**
- **Power factor(PF): >0.9**
- **Light efficiency: 70-100 lm/w**
- **No UV or IR light radiation**
- **Fixture efficiency: >90%**
- **View angle: 40°**
- **Color instruction: >80**
- **Color temperature(CCT): 2600-7000K**
- **Life time: >50,000 hrs**
- **Luminance decrease: keep lighting 1000hours decrease1%**
- **IP grade: IP65**
- **CE certification**
- **Net weight: 7.5kg**
- **Gross weight: 8.5kg**
- **Dimension of the product: 393\*285\*93mm**
- **Dimension of the external box: 46\*34\*42.5cm**
- **Quantity (PCS): 2 pcs in a carton**



## TYPICAL APPLICATIONS:

- **Energy Saving Programs**
- **exterior of building light**
- **on the bill board**



# APPLIED ELECTRONICS ENTERPRISES CORPORATION

TEL: (02) 6224308 FAX: (02) 5598778 MOBILE: (0917) 8878378 / (0922) 8878374

STALL NO. 2M-15 168 MALL STA. ELENA ST., BINONDO, MANILA

URL: [WWW.LED.PH](http://WWW.LED.PH)

EMAIL: [APPLED888@YAHOO.COM.PH](mailto:APPLED888@YAHOO.COM.PH)

## PRODUCT DIMENSIONS:

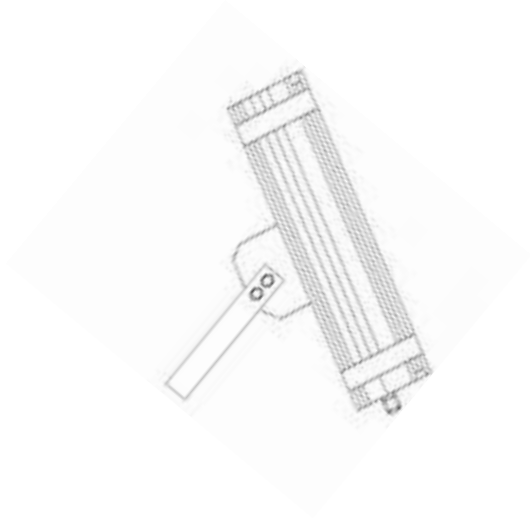
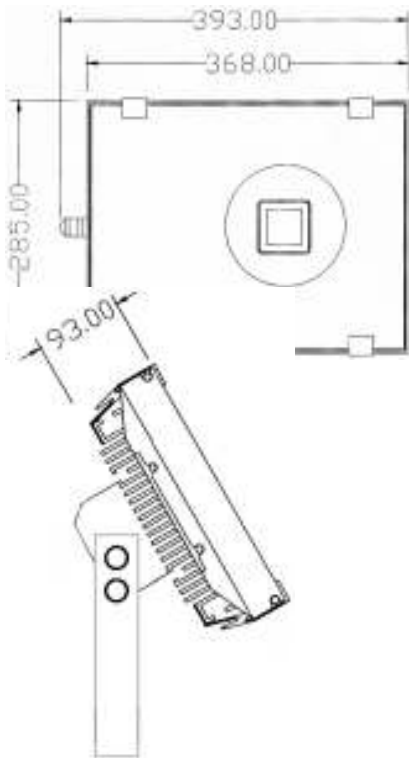

## PHOTOMETRIC RESULTS:

